

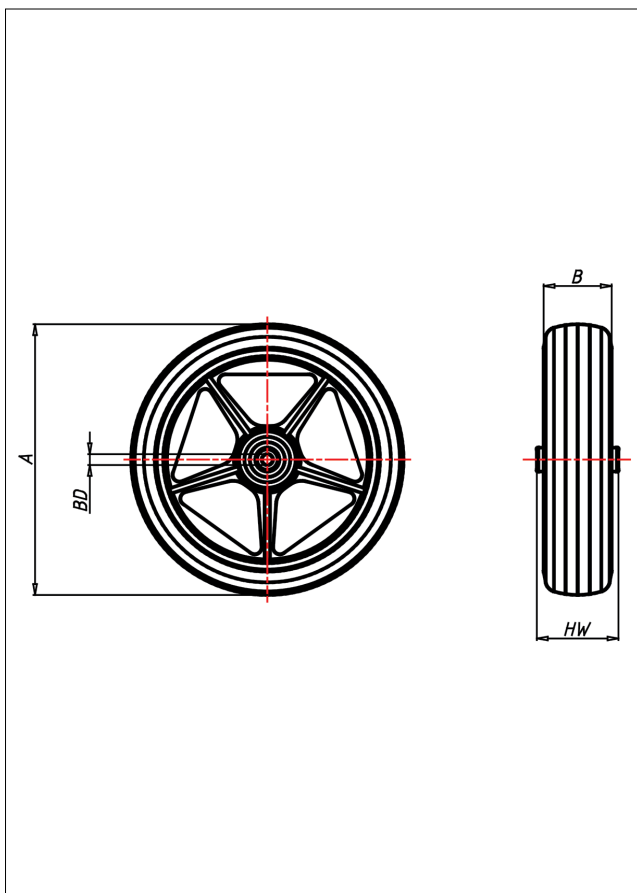

PU Rad

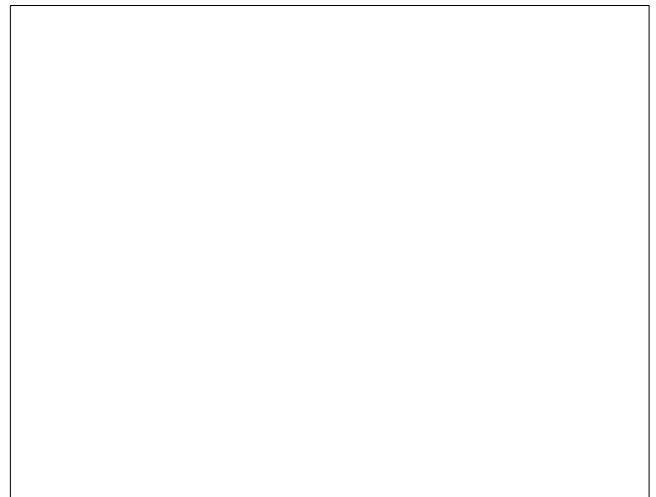

PU Rollstuhlräder



Radkörper aus Polyamid 6 - 1. Wahl
Polyurethan-Reifen, grau

- pannensicher
- spurfrei
- geräuscharmer Lauf
- geringer Rollwiderstand
- abriebfest
- sehr beständig gegen viele aggressive Medien

Technische Details

ORDERNO (Artikel-nummer)	200 PUK 12 NL 60
WDAB (Rad-Ø A x Breite B / mm)	200x50
LC (Tragkraft / kg)	50
HW (Nabellänge / mm)	60
FL (Einbaulänge / mm)	60
WB (Radlager)	2 Rillen-Kugellager
BD (Bohrungsdurchmesser / mm)	12